

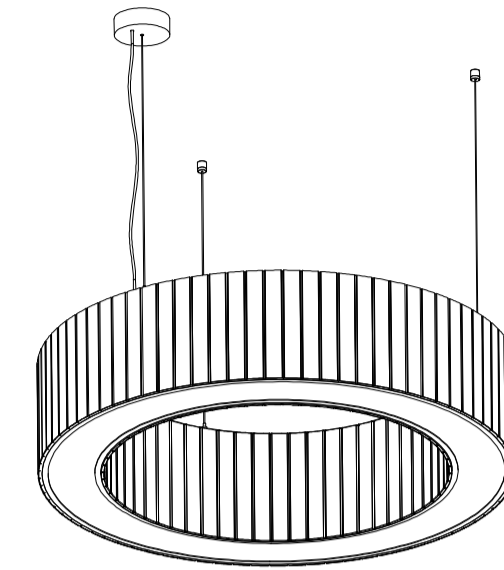

OLENA ACOUSTIC SERIES
ACOUSTIC LIGHTING



OLENA-200



O-H20

DIMENSIONS

Ø800

Ø800 x H:200 mm

Light source
Ø788x200 mm

Ø1000

Ø1000 x H:200 mm

Light source
Ø988x200 mm

Ø1200

Ø1200 x H:200 mm

Light source
Ø1188x200 mm

PROFILE



POWER*

23 W

*mt

LIGHT FLUX*

2300 lm

*mt

COLOR TEMPERATURE

2700K 3000K 5000K

CRI

80 CRI/90 CRI

BEAMWIDTH



Direct

Direct/Indirect

CONTROL TYPES

On/Off

DALI

DIFFUSORS

Opal

Micro Prismatic

BODY COLORS

Black

Gray

White

Color by RAL

ACOUSTIC COLORS

Natural/Mandarin Colors

Natural Colors

MOUNTING TYPES

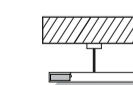

Rod Pendant

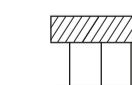

Multi-Point Pendant

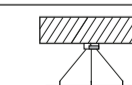

Single-Point Pendant

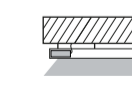

Spacer Surface

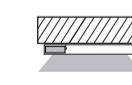

Direct Spacer

*Driver:

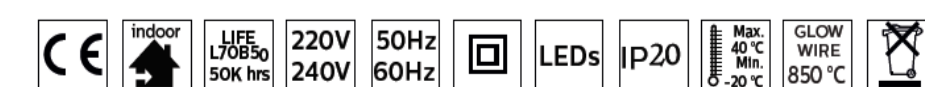

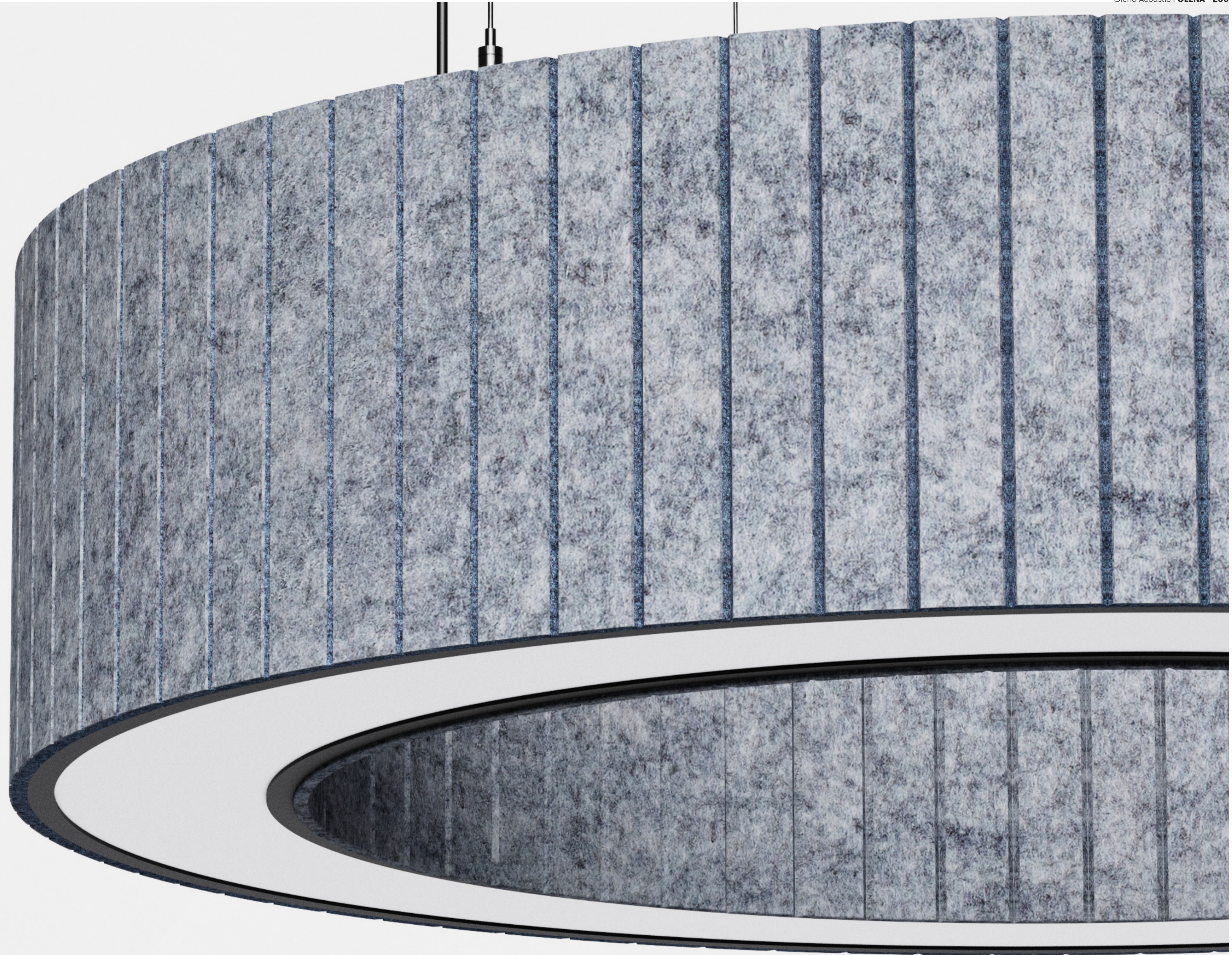



OLENA-D-200

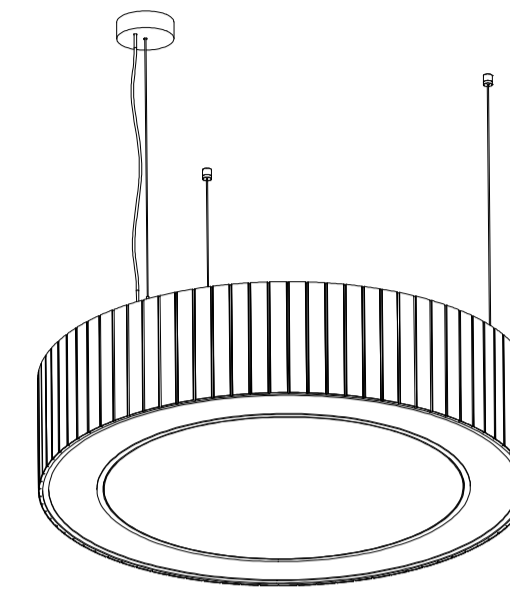

O-D-H20

DIMENSIONS

Ø800
Ø800 x H:200 mm
Light source
Ø788x200 mm

Ø1000
Ø1000 x H:200 mm
Light source
Ø988x200 mm

Ø1200
Ø1200 x H:200 mm
Light source
Ø1188x200 mm

PROFILE



POWER*

23 W

*mt

LIGHT FLUX*

2300 lm

*mt

COLOR TEMPERATURE

2700K 3000K 5000K

CRI

80 CRI/90 CRI

BEAMWIDTH



Direct

Direct/Indirect

CONTROL TYPES

On/Off

DALI

DIFFUSORS

Opal

Micro

Prismatic

BODY COLORS

Black

Gray

White

Color by RAL

ACOUSTIC COLORS

Natural/Mandarin
Colors

Natural
Colors

MOUNTING TYPES

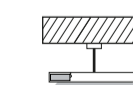

Rod Pendant

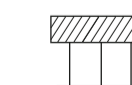

Multi-Point Pendant

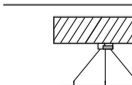

Single-Point Pendant

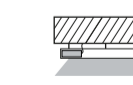

Spacer Surface

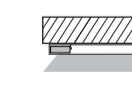

Direct Spacer

*Driver:

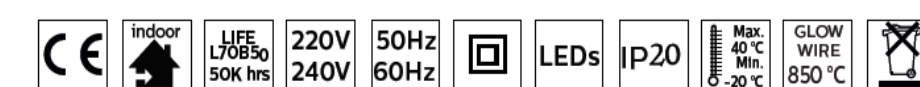

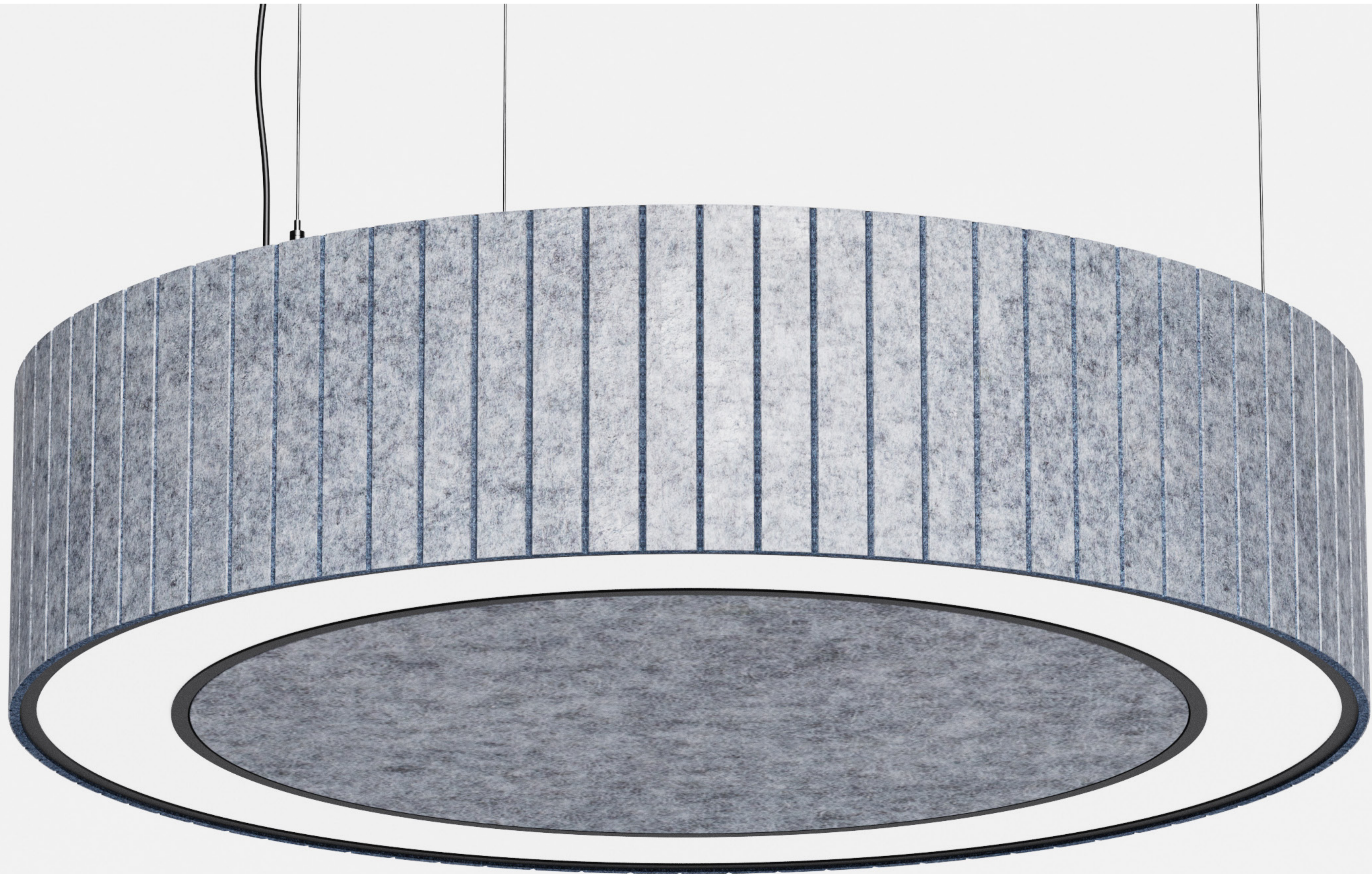



OLENA-300

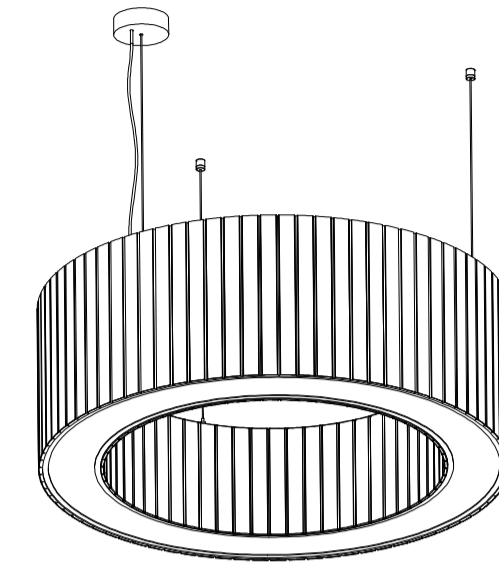

O-H30

DIMENSIONS

Ø800

Ø800 x H:200 mm

Light source
Ø788x200 mm

Ø1000

Ø1000 x H:200 mm

Light source
Ø988x200 mm

Ø1200

Ø1200 x H:200 mm

Light source
Ø1188x200 mm

PROFILE



POWER*

23 W

*mt

LIGHT FLUX*

2300 lm

*mt

COLOR TEMPERATURE

2700K 3000K 5000K

CRI

80 CRI/90 CRI

BEAMWIDTH



Direct

Direct/Indirect

CONTROL TYPES

On/Off

DALI

DIFFUSORS

Opal

Micro Prismatic

BODY COLORS

Black

Gray

White

Color by RAL

ACOUSTIC COLORS

Natural/Mandarin
Colors

Natural
Colors

MOUNTING TYPES

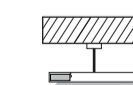

Rod Pendant

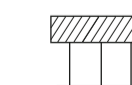

Multi-Point Pendant

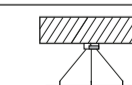

Single-Point Pendant

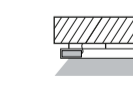

Spacer Surface

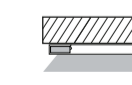

Direct Spacer

*Driver:

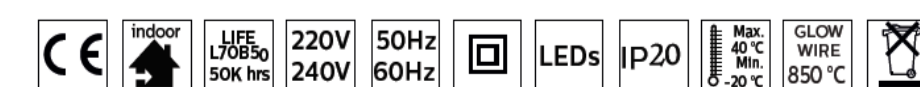

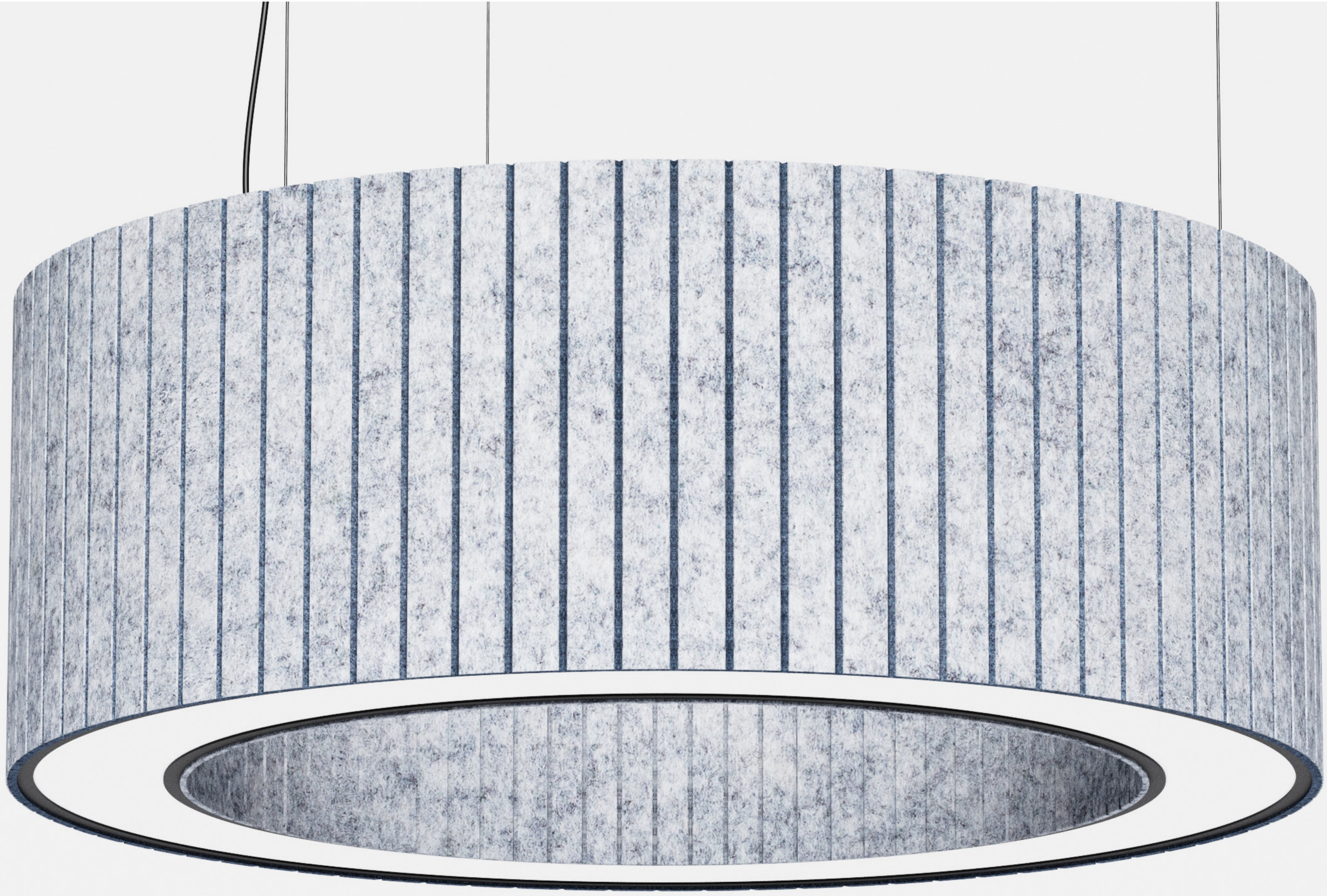





Acoustic Panel Colors

MANDARIN

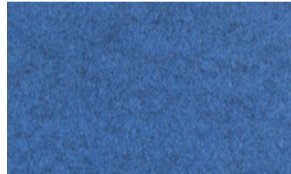

PLC05



PLC10



PLC12



PLC13



PLC16



PLC17



PLC18



PLC22

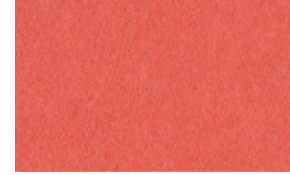

PLC23



PLC25

NATURALS



PLN01



PLN02

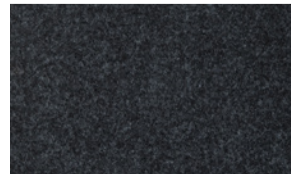

PLN03

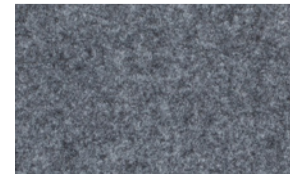

PLN04

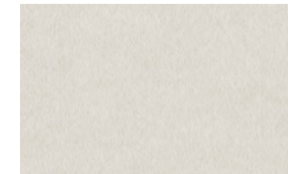

PLN06